

# Apolo Kiosk

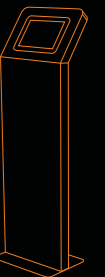

mail: [info@pointkiosk.si](mailto:info@pointkiosk.si) . tel.: +386 (0)5 3305 771 . fax.: +386 (0)5 3305 495

# Kipad

The Multitouch Innovation

The Kipad model is designed for indoor use only and to be integrated into an IPAD. Could be used as an Information Point of the institution / company where it is installed, Internet access point or for any application that can be developed for the iPad.

It can also be used for public or private institutions to attend the clients where, somehow, a management service / waiting queues is needed, by simply installing a printer for tickets.

Through a glossy widescreen Multi-Touch 9.7-inch you can quickly see the information you are looking for.

All the iPad applications were designed to take advantage of the Multi-Touch display and the advanced capabilities of IPAD.

The glass is scratch proof so, even when exposed to a massive use, will not damage the multi-touch screen.

This model can be manufactured in stainless steel AISI 304 or painted steel (available in all RAL colors) using steel plate of 1,5mm to 2mm.

Kipad can be equipped with an A4 Apple Chip with 1 GHZ, high performance and low power, Wi-Fi (802.11 a / b / g / n), Bluetooth 2.1 + EDR, etc.

## Technical Specifications Kipad Kiosk

Dimensions: H1200 x W350 x D300  
Weight: aprox. 19 Kg.



Balcony Kipad

IPAD is a trademark of Apple Inc., registered in the U.S. and other countries

The Ipad  
Kiosk

Kipad  
The Multitouch Innovation

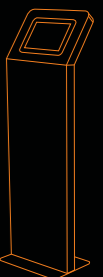

# Kipad

Distance comparison and main features

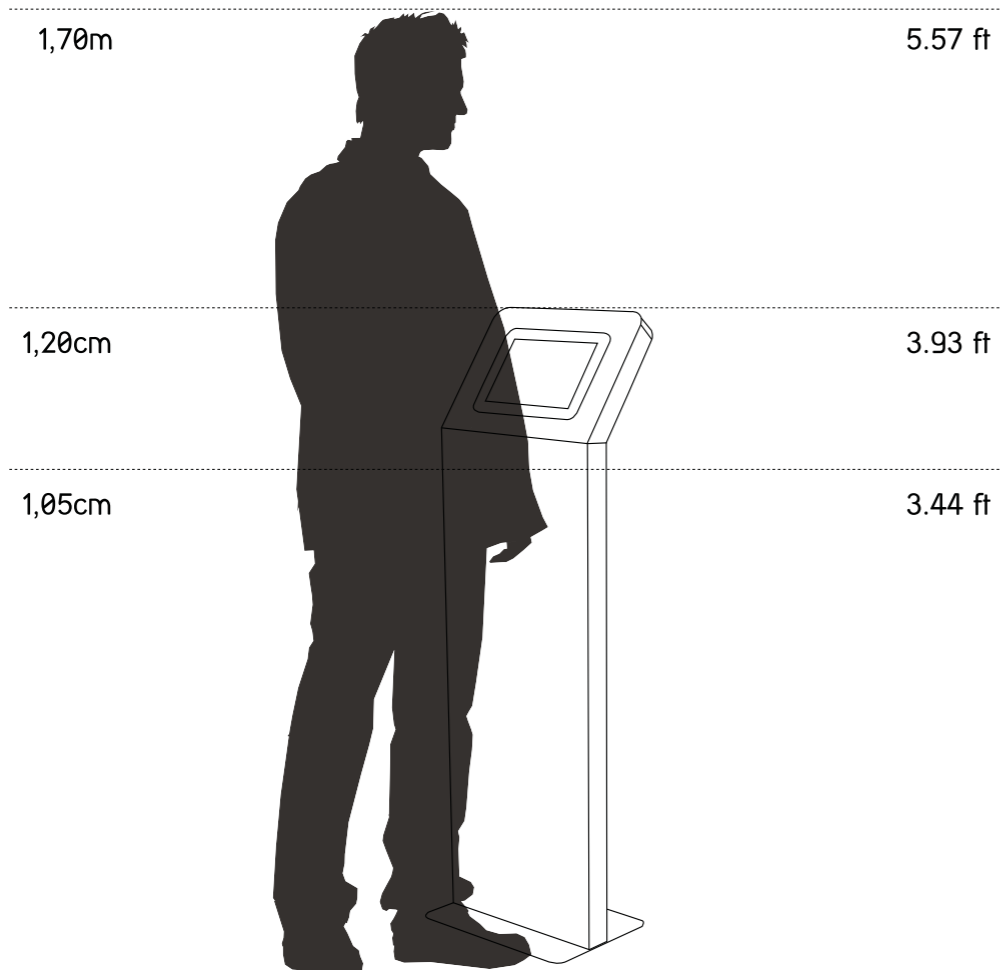

## Type

Indoor

## Materials

Painted Steel

Stainless Steel

MDF

## Options

Ticket Printer

Card Reader

Bar Code Scanner

Chip Reader

IPAD is a trademark of Apple Inc., registered in the U.S. and other countries

Kipad  
Distance comparison and main features

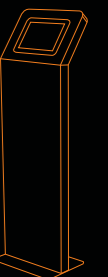

# Kipad

Kiosk measures

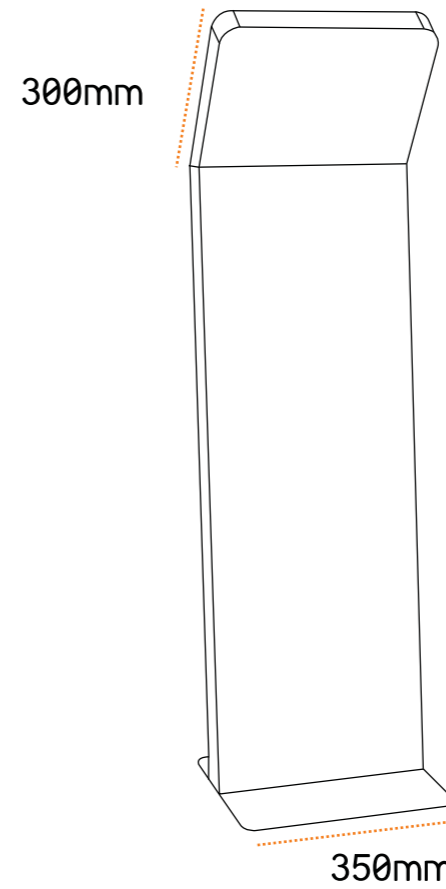
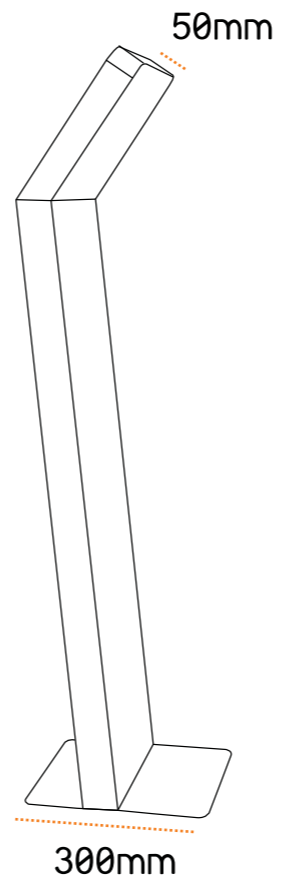
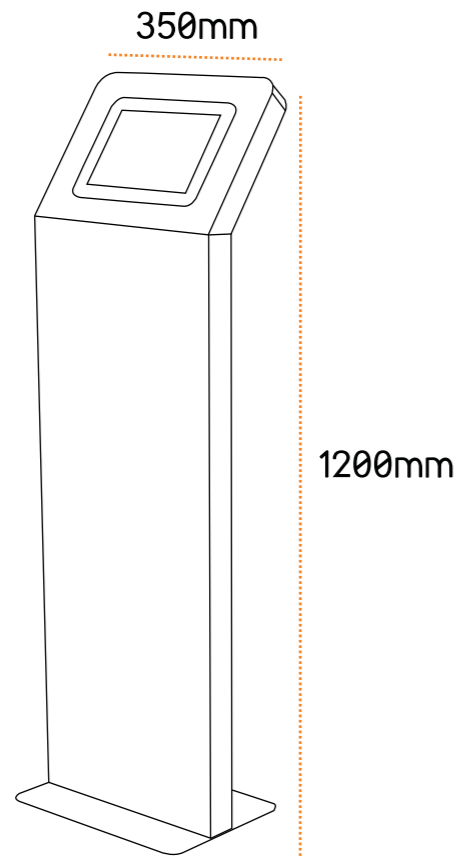

IPAD is a trademark of Apple Inc., registered in the U.S. and other countries

Kipad  
Kiosk measures

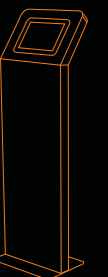

# Kipad

Technical data

---

## Dimensions:

- H1200 W350 D300

## Weight:

19 kg

## Configuration:

- The multitouch Innovation
- Stainless steel AISI304 (front) and painted steel (rear)
- Steel plate of 1,5mm to 2mm
- Glossy widescreen Multi-Touch 9.7-inch (diagonal) LED-backlit IPS technology.

## Computer

- IPAD
- A4 Apple Chip 1 GHZ, high performance and low power consumption
- H.264 video up to 720p, 30 frames per second, Main Profile Level 3.1 with AAC-LC up to 150 Kbps





info@pointkiosk.si . tel.: +386 (0)5 3305 771 . fax.: +386 (0)5 3305 495

COBIT d.o.o., Industrijska cesta 5, Kromberk - p.p.235 -5001 Nova Gorica