

Dink Kiosk

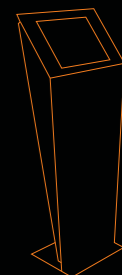

mail: info@pointkiosk.si . tel.: +386 (0)5 3305 771 . fax.: +386 (0)5 3305 495

Dink

Modern and Stylish

The Dink model was developed for indoors use to work as stand up kiosk.

This model can be manufactured in stainless steel or painted steel (available in all RAL colors) using steel plate of 1,5mm to 2,5mm which ensures the stability and rigidity of the all structure.

This Dink model is normally equipped with a tactile monitor and can be delivered with a anti vandalism keyboard with trackball, card reader, webcam, coin acceptor, tickets printer, handset phone and other peripherals. This model can be equipped with a anti vandalic monitor.

The area where the computer is installed and possible peripherals (card readers, coin acceptors, etc.), is protected with access through a security lock and includes three power plugs.

The Dink Model is normally equipped with a 17" XGA touch display (19", 22" or other sizes are possible).

On the side of the monitor are two speakers and the kiosk has 2 independent systems of ventilation, one for the monitor and other for the PC.

The Dink Model is normally equipped with a Atom CPU with a 160 GB hard drive, 1 Gb Ram Memory, a 128Mb graphic card and a 10/100 mb ethernet, Windows 7 Starter.

Technical Specifications Dink Kiosk

Dimensions: H1200 x W500 x P90,30
Weight: aprox. 30 Kg.

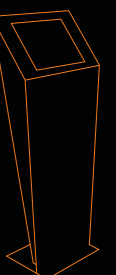

Dink

Distance comparison and main features

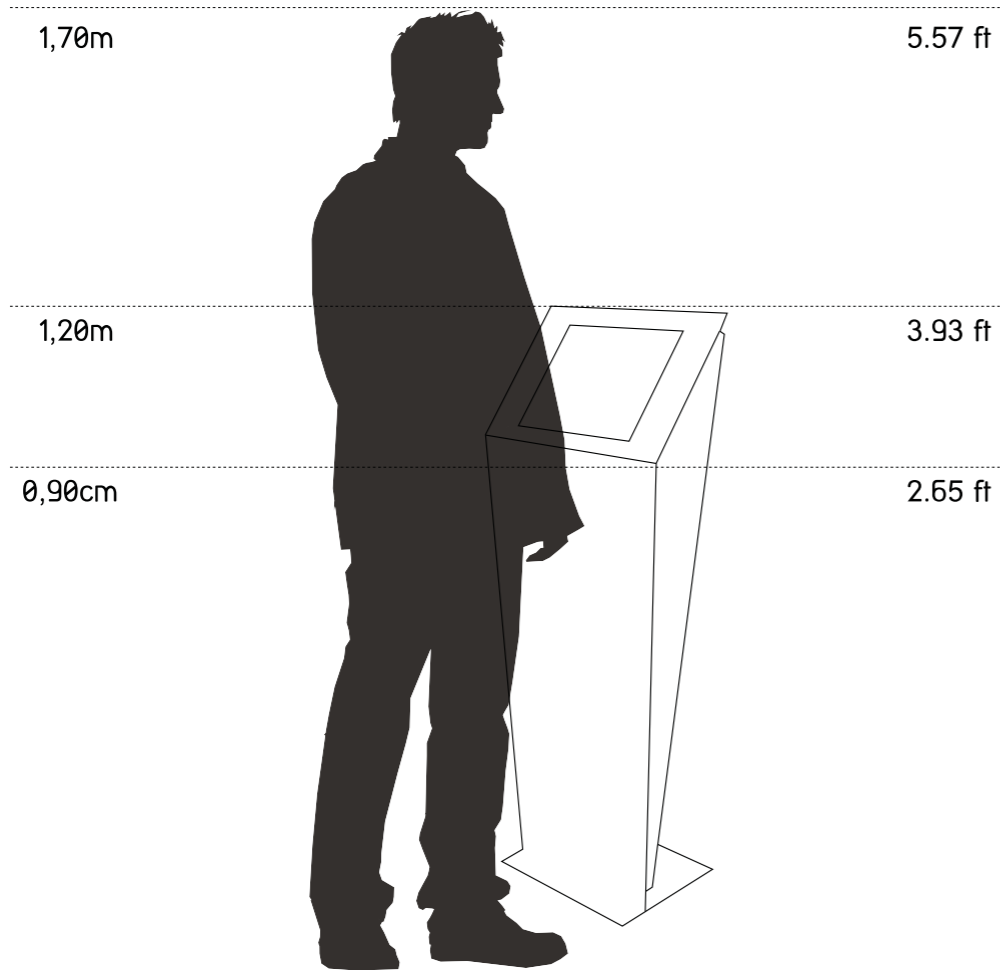

Type

Indoor

Materials

Painted Steel

Stainless Steel

MDF

Options

Webcam

Ticket Printer

Card Reader

Antivandalic Keyboard

Bar Code Scanner

Handset Phone

Coin Validator

Bill Validator

Ykiosk Software

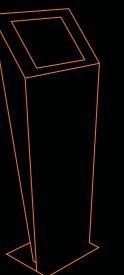

Dink

Kiosk measures

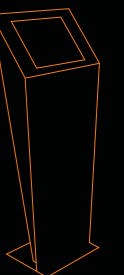
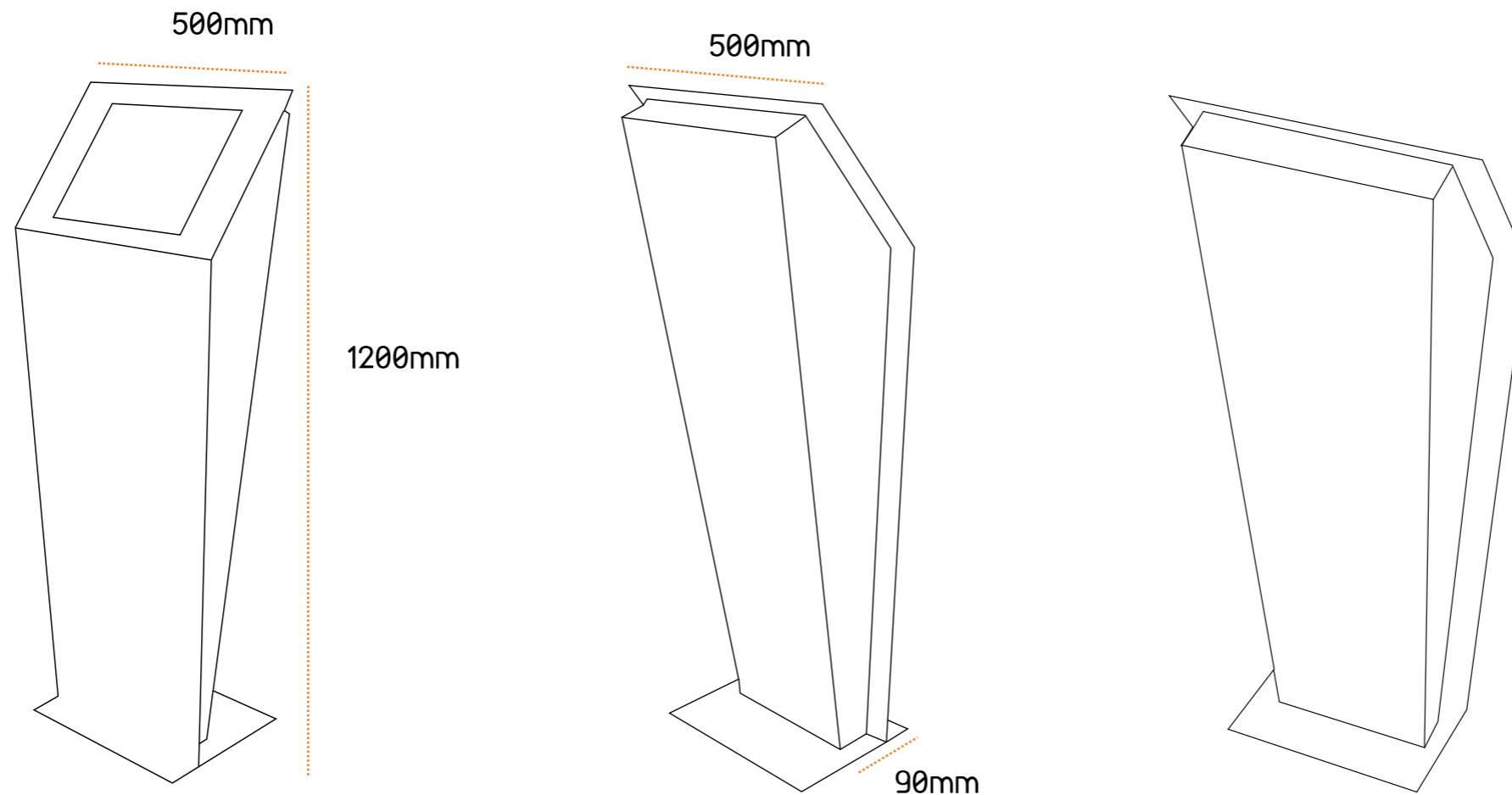

Dink

Technical data

Dimensions:

- 17" Display (resolution: 1280 x 1024 Pixel)
- H1200 W500 D(90,30)

Weight:

30 kg

Configuration:

- Modern and Stylish
- Stainless steel AISI304 or painted steel (RAL Colors)
- Steel plate of 1,5mm to 2,5mm
- 17" XGA touchscreen display (resistive)
- Integrated speakers

Optional:

- 19" to 24" Displays
 - Atom or Dual Core PC computer
 - Microsoft Windows 7 Professional
 - Ykiosk software package
 - Touch screen (SAW - antivandalism)
 - Wireless networking - WLAN
 - Bluetooth functionality
 - Webcam
- Other components can be integrated changing kiosk dimensions: ticket printer, coin validator, bill validator, card readers, antivandalic keyboard, proximity sensor, etc.

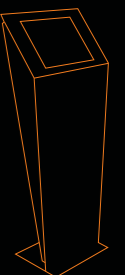



info@pointkiosk.si . tel.: +386 (0)5 3305 771 . fax.: +386 (0)5 3305 495

COBIT d.o.o., Industrijska cesta 5, Kromberk - p.p.235 -5001 Nova Gorica